

Atlas Copco

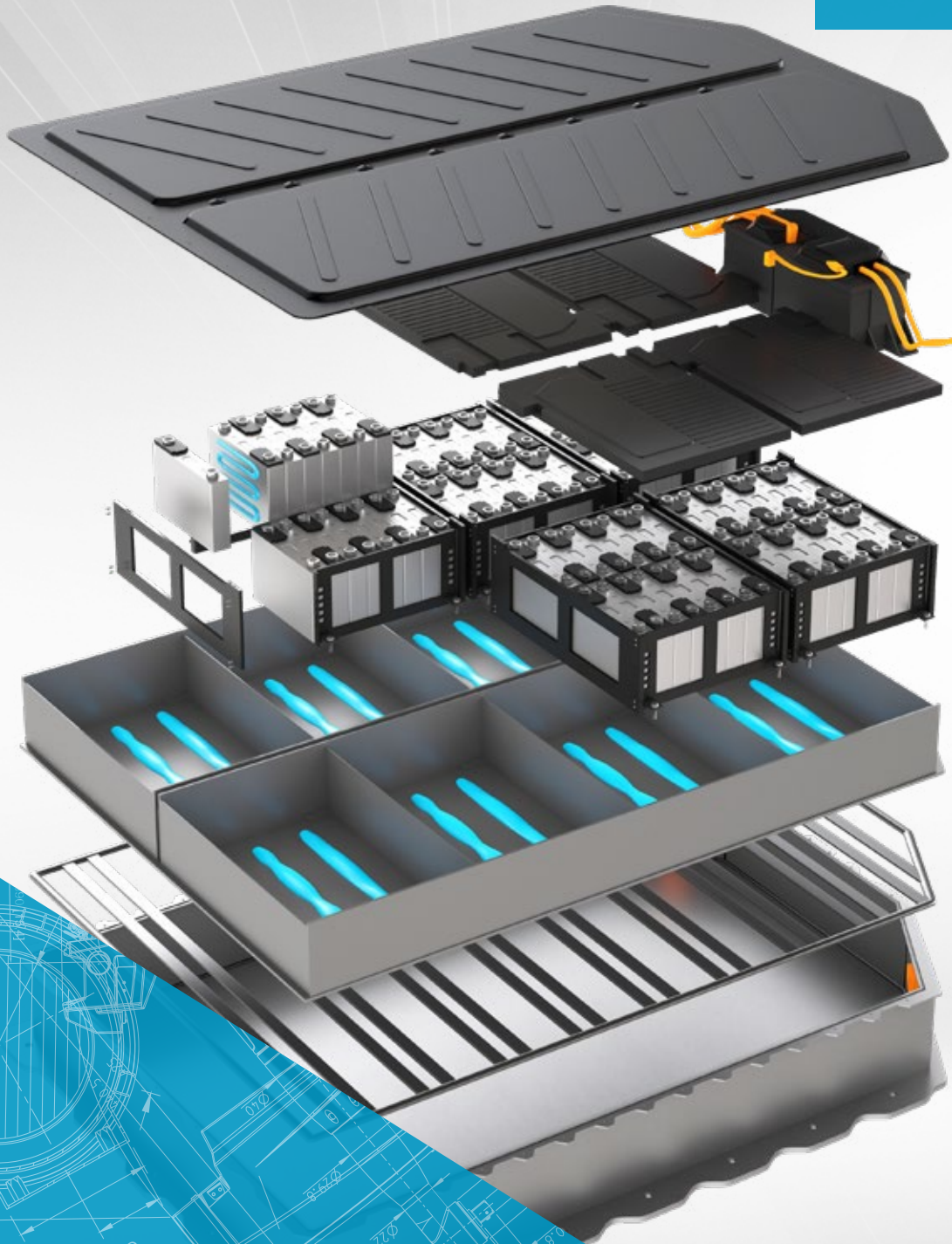

Innovating battery assembly

Solutions that bring productivity, quality,
and sustainability in e-mobility and battery
manufacturing to a new level





Your innovation partner for e-mobility manufacturing

- 04 Team up
Innovation partnership
- 06 Battery
Assembly process
- 08 Step 0/1
Cell component and cell inspection
- 10 Step 2/3
Cell stack and module assembly
- 12 Step 4
Battery tray assembly
- 14 Step 5
Thermal management
- 16 Step 6
Assembly of modules
- 18 Step 7
Assembly of electrical components
- 20 Step 8
Battery sealing
- 22 Step 9
Fire protection
- 24 Step 10
Cover joining
- 26 Step 11
Corrosion protection
- 28 Battery
Cylindrical cells
- 30 Design
Self-pierce riveting in body shop
- 32 Quality
Integrated vision solutions
- 34 Innovation
Worldwide Innovation Centers
- 36 Sustainability
Reducing emissions in e-mobility
- 38 Service
Productivity and cost control

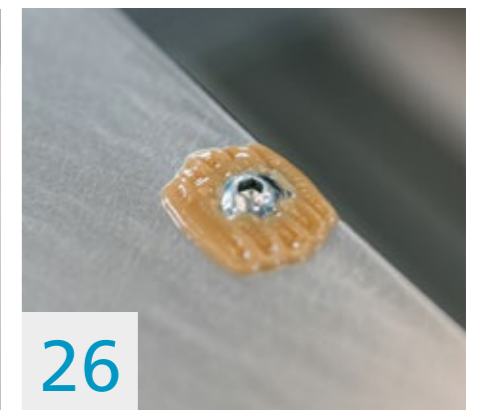
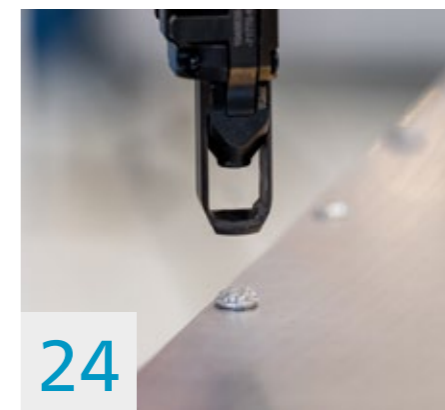
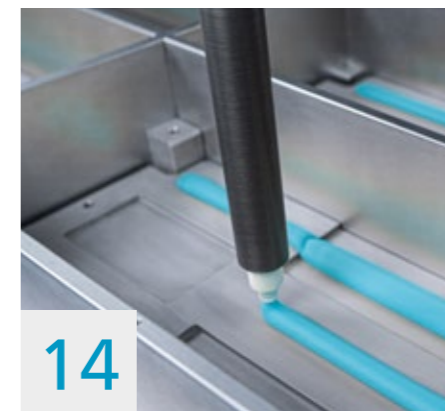

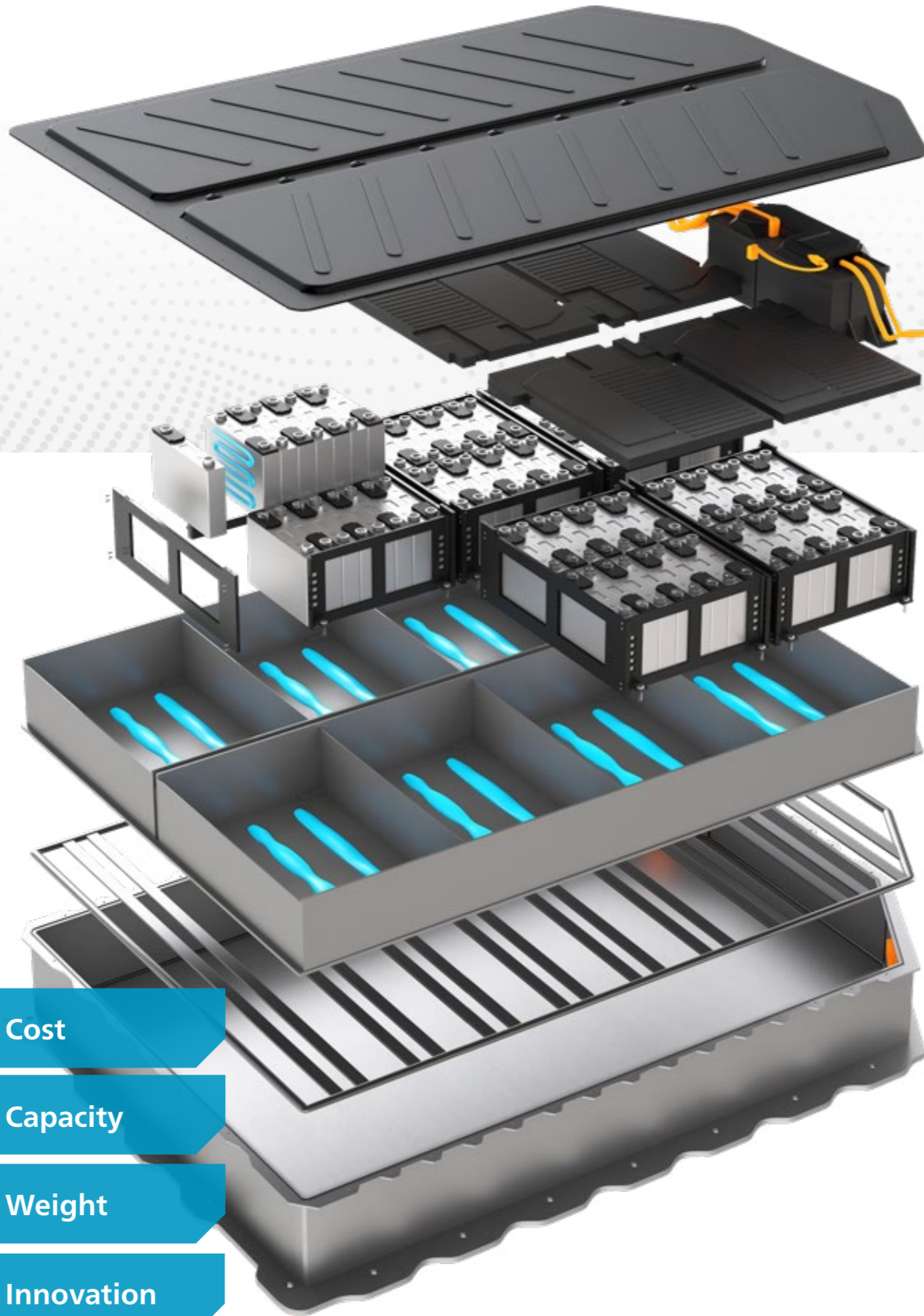

Self-pierce riveting



Flow drill fastening



Adhesive potting + injection



Adhesive bonding + sealing



Machine vision solutions



Tightening solutions



Data-driven process optimization

Driving the future of electric vehicle battery production

The world of electromobility and battery manufacturing is rapidly evolving, and the highly diverse battery manufacturing processes demand innovative solutions. Many factors influence decisions regarding the concept and production of new EVs and their batteries, like battery range and safety, the optimal joining technologies, and how to reduce car weight without structural performance loss.

Innovative, safe, and efficient assembly process solutions

Assembling electric vehicle batteries comes with many new and existing applications. At Atlas Copco, we know and understand the entire value chain of battery production. With our broad portfolio and process competence, we offer solutions for mechanical joining and tightening, bonding, sealing, and potting combined with machine vision solutions and data-driven services.

This includes: Assembly tools that are fast and accurate. Dispensing and potting systems that ensure consistent, bubble-free application. Self-pierce riveting systems that can securely join mixed materials without damage. And flow drill fastening to create reversible secure joints where there is only one-sided access.

Thanks to integrated machine vision solutions, perfect calculation of material and application is given, and even minimal deviations or defaults are detected. To complement these, error-proofing solutions with full process control deliver "right first time" production and quality assurance, including calibration, measurement, and reporting. Therefore, faults are fixed cost-effectively, and every assembly is fully traceable.

Our service solutions and the global service organization help you to get the most out of your industrial equipment by combining analyses of production data with expertise to enhance your productivity and quality while keeping your maintenance cost under control.

Fast-changing process requirements demand flexibility





Battery manufacturers are challenged by time to market and high throughput targets. Production processes and materials are continuously adjusted and changed. Since there are no standards, every manufacturer has the target to reduce cost, material, and process steps while increasing quality, productivity, and safety.

The production processes are based on the choice of battery cell type. Depending on region, platform and model, prismatic as well as cylindrical cells are trending. Flexibility in joining and dispensing is therefore key, especially when it comes to the application of low viscosity materials. With our two product lines SCA and Scheugenpflug, we have a unique flexibility between different bonding, sealing, potting and injection solutions.

Innovation is key

In our global Innovation Centers, we develop, test and optimize application processes together with customers and material manufacturers. Thanks to the machine vision technology from the acquired companies ISRA VISION, Perceptron and QUISS, our applications measure material volume, precisely position our systems, guide the robot, inspect the application quality, and control the overall process which results in efficiency, increased safety as well as savings in material cost and waste.

CHALLENGES

-  Cost
-  Capacity
-  Weight
-  Innovation
-  Defects
-  CO₂ footprint

Scan to watch the video and find out why we are your innovation partner:





From single cell to ready-to-use battery pack

EV batteries have become an integral part of the vehicle structure, making lithium-ion cell assembly and their integrity a safety-critical issue. One major differentiating feature of battery concepts and designs is the cell type. The typical cell types on the market are currently cylindrical cells, prismatic cells, and pouch cells. Many manufacturers use prismatic cells since they can be stacked efficiently.

Production processes can vary greatly depending on the cell type.



We have outlined a complete battery assembly process for prismatic cells – from the single cell to the finished battery pack. We help our customers develop unique joining processes and select the technologies that best fit the individual requirements and challenges of each battery assembly step.

All cell types have in common: They are highly sensitive power packs. No heat or mechanical force that could damage the cells is allowed. Non-intrusive joining solutions in combination with appropriate quality assurance are the first choice.



[Learn more:](#)



Reliable automated inline inspection in battery cell production

- ! Create only flawless material and ship only flawless battery cells
- ! Inspection at full production speed and detection at full web width
- ! Entire cell inspection at full in-line production speed

The battery components are the centerpiece of the final electric battery that will power an electric vehicle (EV). Using inspection systems to early detect and monitor component and product quality ensures resource and cost efficiency. It is also of significant importance, for product safety in later production stages.

CHALLENGES

The coated electrode materials for cathodes and anodes must meet the highest requirements in terms of energy efficiency, storage density and of course, safety. Another component of the battery cell with extreme quality requirements is the lithium-ion battery separator film. The film is an essential safety element that will prevent a short circuit in the battery and plays a significant role in cell speed and service life. The film must possess flawless porosity and uniformity for use in a battery cell but must also have solid chemical stability and be resistant to heat and tearing.



OUR SOLUTION

The ISRA VISION SMASH Battery inline inspection system offers a comprehensive and reliable quality assurance solution detecting and classifying all surface defects. SMASH systems check electrode material quality for damage such as streaks, holes and impurities. They inspect and measure both the coating lanes, their top and bottom allocation and the edges on the web. SMASH can also be utilized in the classification of production defects in the PVDF fluoroplastic coating used for separator film for holes, stains, oil, water drops and scratches. This high-end inspection is made possible with high-resolution 8 and 16k cameras and multi-scan technology with up to three simultaneous scans.

When it comes to high-performance battery cells, the ISRA VISION PouchSTAR cell inspection system offers a complete 360° optical view of cells to ensure a 100 % comprehensive inspection. In addition to dimensional monitoring, cell inspection detects surface defects and contamination. Defects are classified and defective cells are automatically ejected or marked. The system also reliably checks barcodes and data codes and ensures a fully traceable production documentation.

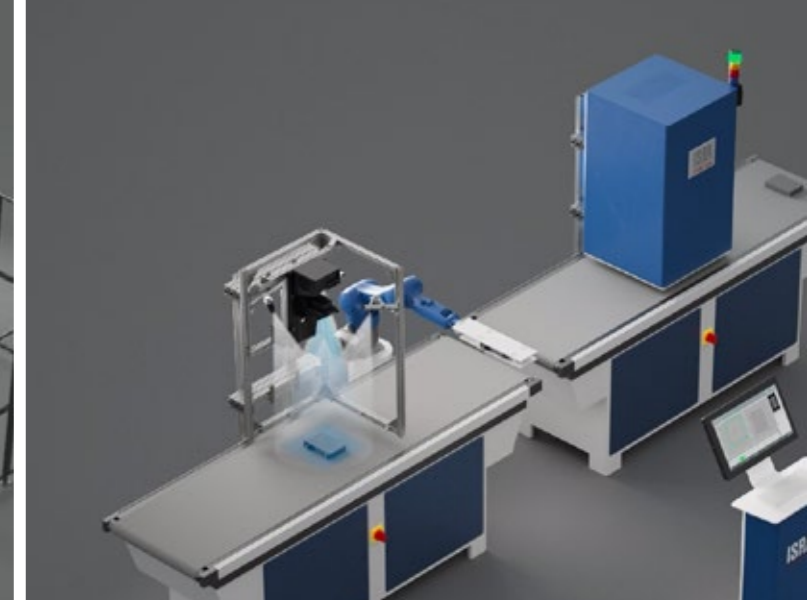
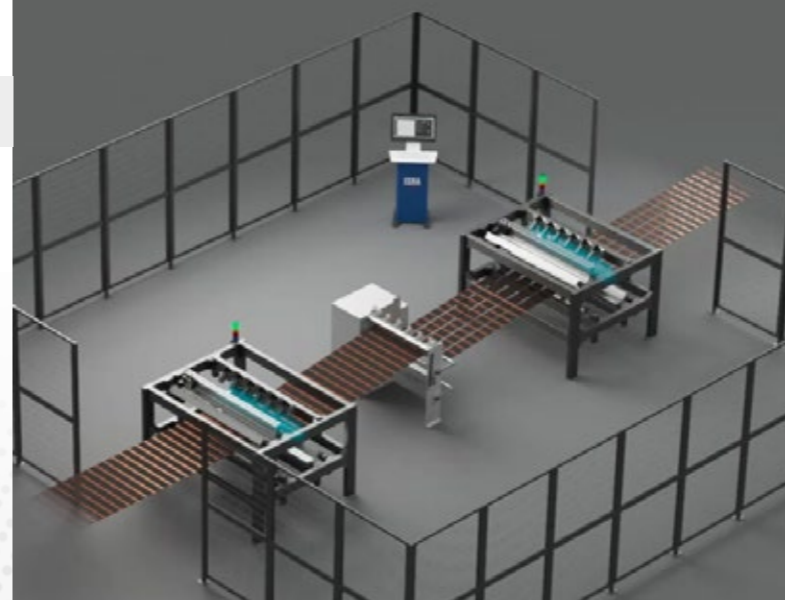

- ✓ Inspection of material quality over the entire web length and width
- ✓ Reduced operational costs and streamlined manufacturing processes
- ✓ 100 % inspected cells for perfect detection and classification as defects are classified and defective cells are automatically ejected or marked
- ✓ Utmost product safety to avoid recalls and incidents

Minimized waste, reduced raw material and energy consumption



SEPARATOR FILM INSPECTION

- Line speed: 120–250 m/min.
- Line width: Main lines: 4.500–7.000 mm, Slitting lines: 1.200–1.400 mm
- System resolution: 50–100 µm



ELECTRODE COATING INSPECTION

- Web width: 300–1.000 mm
- Line speed: typical 50 m/min
- Resolution: 25–100 µm

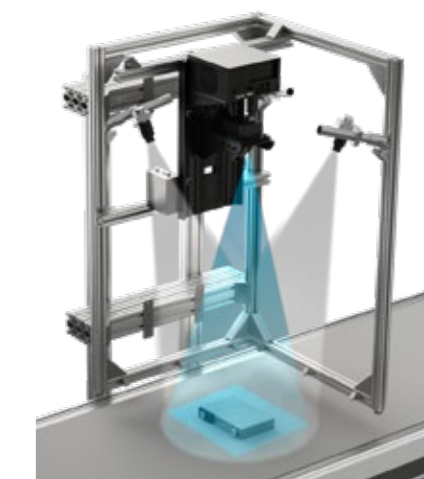

CELL INSPECTION SYSTEM

- Tact rate at automotive pouch size: ca. 15 ppm
- Required tact time: 4 s
- Target defect size: > 50 µm



Cell and sidewall bonding right first time



- ! Multiple bonding tasks at short cycle times
- ! Handling of two component materials
- ! Ensuring process and application quality right the first time

Cell stack and sidewall bonding are critical processes in the production of batteries for electric vehicles. The cells must be securely joined, while maintaining electrical insulation and allowing for cell expansion during charging and discharging. These processes require precision, speed, and flexibility to ensure the production of high-quality batteries that meet the stringent safety and performance standards of the automotive industry.

CHALLENGES

The different battery cell types present unique challenges. For batteries with prismatic cells, the challenge is to firmly attach the cells to a stack. No heat or force can be applied, and the joint must meet the highest demands in terms of application quality, rigidity and crash behavior. Similar challenges appear when bonding the sidewalls around the cell stack. This is why two-component (2C) materials are often used for this process, as they do not require heat for curing. However, these materials are demanding to process. To ensure a safe bond, the application and process quality need to be right the first time.

OUR SOLUTION

To meet the application quality right the first time, we offer a solution bundle of an in-line bead inspection system and a high-performance metering unit.

For in-line inspections, the Atlas Copco RTVision.t and RTVision.3d sensors are reliable solutions that can meet those high-demands with ease. Both can detect errors in width, position, and continuity of the bead, providing direct feedback and allowing immediate reaction. With its automatic bead repair functionality, the RTVision.t can correct detected application gaps within the same sequence. If it is required in the customer's quality strategy, the RTVision.3d can perform a 360° inspection – including the height of the round bead and the applied material volume.

With the Atlas Copco SCA industrial dispensing metering units, a complementary bundle can be made. Our portfolio covers a broad variety of applicators that are highly precise, avoid air pockets and ensure high process reliability. Depending on the customer's requirements, we offer 1C and 2C applications. The high metering accuracy and mixing quality of our systems allows us to handle even advanced 2C applications with high speed and constant quality.

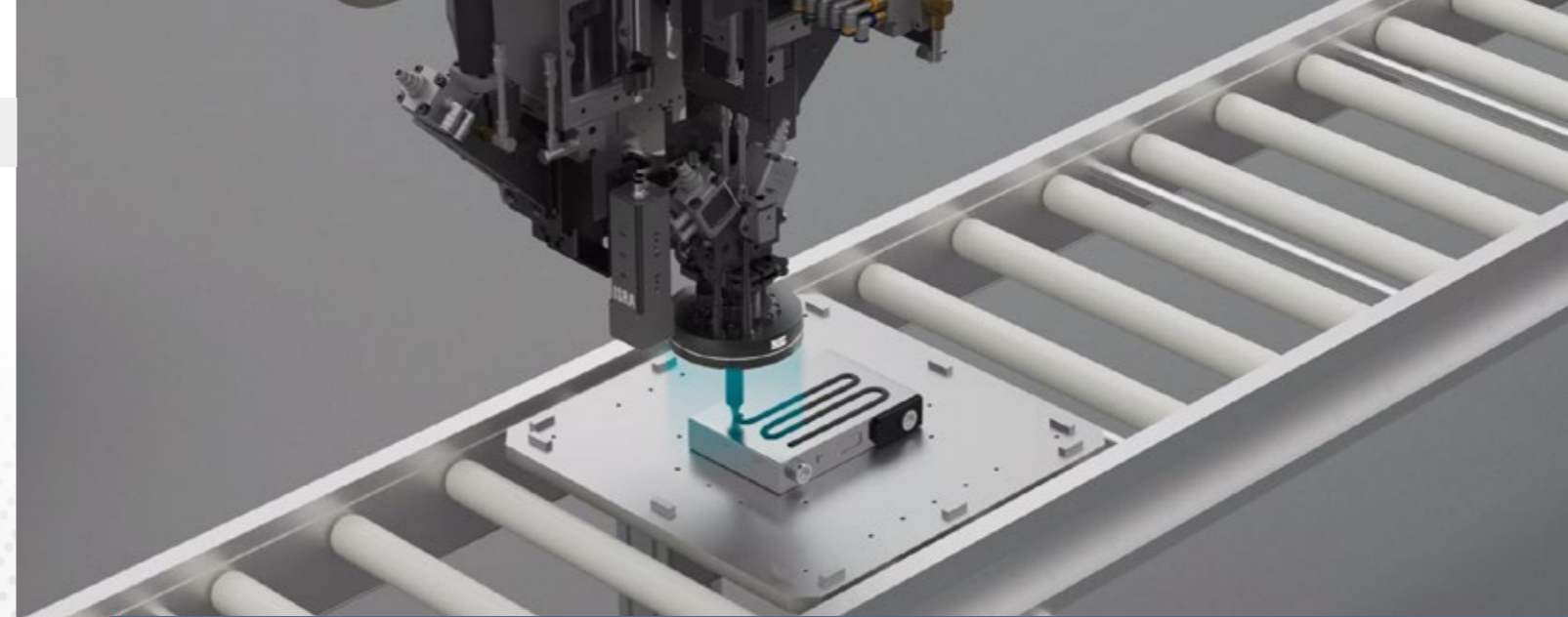

- ✓ Fast and precise bonding with high process reliability
- ✓ Full flexibility in mixing ratios and application patterns
- ✓ 1C and 2C applications tailored to customer requirements
- ✓ Quality control with integrated in-line bead inspection

Reduced rework and waste due to maximized application quality



2C METERING UNIT

- Static mixing valve for precise mixing of two component materials
- Full flexibility in mixing ratios depending on customer process
- Monitoring of volume and mixing ratio
- High flow rates and robot speeds possible



RTVISION.T

- Inspection of all conventional adhesive and sealant application types and colors
- Integrated bead repair functionality
- Different lighting options for different materials

STEP 4 | Battery tray assembly

Watch Micro-Webinar



Strong joining of battery trays for optimal performance and structural stability



- ! The battery box is a key structural member of the body with torsional stiffness
- ! High stability to protect the battery during crash situations and everyday use
- ! Joining methods that produce heat and debris can contaminate the battery box

After the battery module is assembled, it needs to be placed into the battery tray. As this tray is a key structural component of the vehicle as well as integral in protecting the battery cells, it needs to be of the highest strength and stability.

CHALLENGES

A wide range of materials are used in helping the battery box perform its primary functions – housing and protecting the battery stacks during everyday use and crash situations, as well as performing as a key structural member of the body in torsional stiffness requirements. The various and high-strength materials required to achieve this robustness can be difficult to join securely and consistently. Additionally, heat and debris must not contaminate the battery tray and its important contents during assembly. The later an error is detected, the more it costs to adjust. Error detection at source improves productivity and quality while reducing costs!



An extensive range of Henrob self-piercing rivets offers the optimal solution for every application

OUR SOLUTION

Atlas Copco's self-pierce riveting (SPR) systems offer a clean and reliable solution for joining the compartment walls to the tray while maintaining torsional stiffness requirements.

Strong enough to pierce the high-strength aluminums or steels needed in this application, our extensive range of Henrob self-piercing rivets are able to transmit loading and electrical conductivity without the harmful fumes, heat, or welding splatter inclusions that weaken and contaminate the battery box. Additionally, self-pierce riveting joints are inherently corrosion-resistant, further protecting the vulnerable battery from the elements in the underbody of the vehicle.

Different feeding options improve productivity and allow the flexibility needed for multiple joint types in one cell. System options such as a die check camera improve the quality. Our in-house joint development, production and validation result in a customized solution, fulfilling the exact need of the application.

The battery tray assembly consists of several production steps. Depending on the battery design and manufacturing processes, manual tightening with bolt positioning and process control, or flow drill fastening with K-Flow technology can bring the needed process quality, productivity and flexibility.

- ✓ Strong multi-layer joints of multiple materials, including high-strength materials
- ✓ High productivity with short cycle times and lean cell operation from reduced process steps
- ✓ Non-thermal joining for a safe and clean environment
- ✓ High flexibility to reduce investment costs and best fit the customer requirements

Self-pierce riveting has a low carbon footprint, consuming less energy and compressed air, as well as sustainability initiatives at the core of our product manufacturing



SELF-PIERCE RIVETING

- Extensive range of rivets for any joining challenge
- Long stroke, long nose self-pierce riveting setters for accessibility
- Range of feed systems for highest productivity

FLOW DRILL FASTENING

- Ideal if one-sided access only
- High operational efficiency thanks to fewer process steps and reduced contamination
- Magazine technology for decreased cycle times

ERROR PROOFED TIGHTENING

- High-accurate tightening with perfect positioning and ergonomics
- Articulated arm, positioning system and operator guidance provide full process control

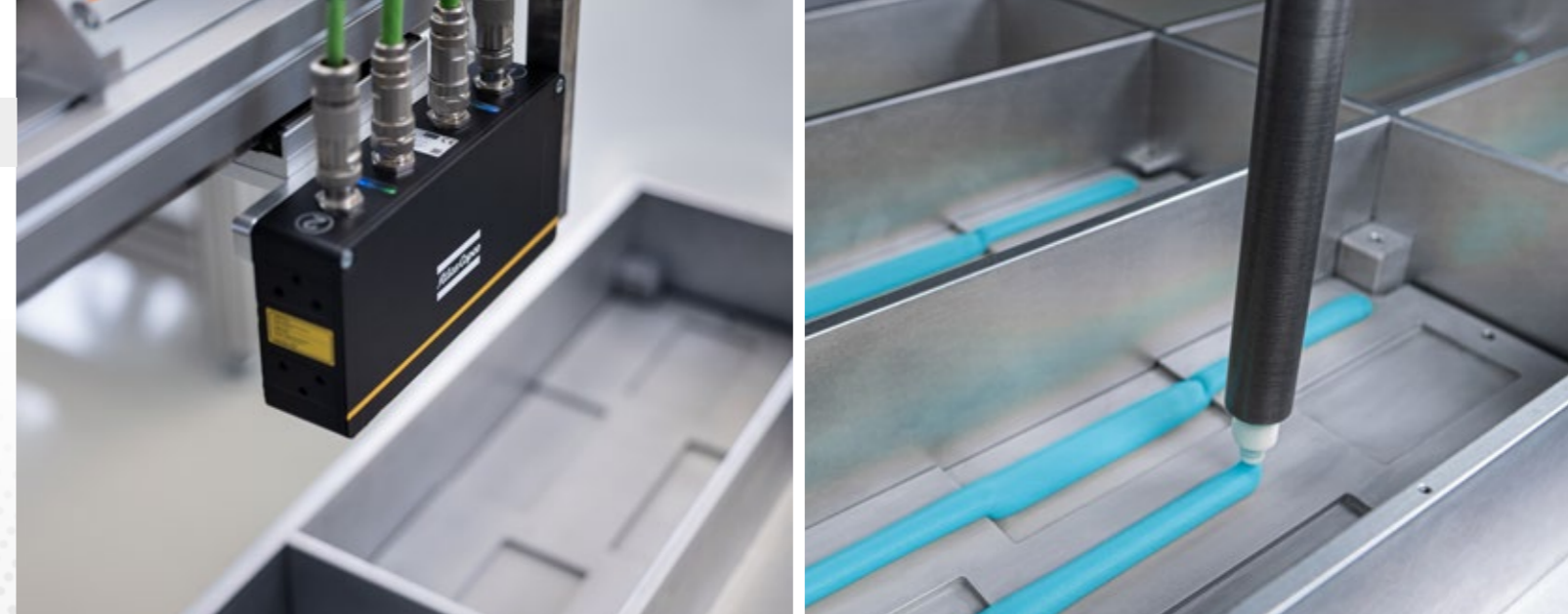

Smartly adjusted gap filler application



- ❗ *Heavy and costly thermal interface materials*
- ❗ *Significant gap tolerances must be compensated*
- ❗ *Safety-critical process: No air inclusions or squeeze-out acceptable*

Battery cells generate heat during charging and discharging, which must be controlled and distributed for safety and to maintain long-term battery capacity. A thermal interface material (TIM) is applied between the battery tray and the cell modules to prevent overheating. This enables active thermal management of large battery packs by dissipating the generated heat into appropriate cooling structures.

CHALLENGES

Thermal interface materials are enriched with special filler particles, leading to high weight and cost. Therefore, this step in the joining process is a major challenge in terms of overall weight and range, cost, and carbon footprint.

Tolerances in the fit between the battery compartment and the cell module must be considered. If too little material is applied, this can lead to insufficient filling and air pockets. Too much material leads to squeeze-out and material waste. Overpressure can occur during cover assembly, which can damage the sensitive cells. All this effects the performance and safety of the battery.

Due to the high density of the gap filler, barrels are often only half-filled, increasing the number of barrel changes needed. Conventional pumps often do not empty a barrel entirely and must be ventilated and purged manually after a change. This leads to high efforts, decreased productivity and material waste in the supply process.

OUR SOLUTION

„Smart.Adjust“ combines a 3D scanning system and a smart software solution that precisely adjusts the material volume. The integrated solution scans the battery tray surface and the module bottom side, and calculates the required volume to fill the gaps. The application system adjusts the parameters for each bead section accordingly. This significantly improves the quality and reliability of the thermal management process. It reduces rework, saves valuable material and weight, and protects the cells from overpressure.

The Enso 7000 Plus.Supply significantly reduces waste in the material supply process. A particular combination of a vacuum pump with a flat follower plate increases the material yield and reduces the number of barrel changes.

Two new options – U-frame for quick-change pallet and a slide-out plate with 360° turntable – make the barrel change even faster and easier. Together with the half-automated, sensor controlled technology, this further increases the safety, quality and productivity of the process.

- ✓ Optimized gap filler application increases quality and productivity
- ✓ Reduced barrel changes and improved barrel change process
- ✓ Smart.Adjust saves up to 20% material and costs (up to 2 kg less material weight per battery)
- ✓ Plus.Supply increases material usage up to 99,4%, accumulating to 500 k€ in five years per double-barrel pump

Strongly improved overall CO₂ footprint and battery range due to material savings, less scrap, material efficiency and lower car weight



SMART.ADJUST

- Reliable, repeatable inspection in the micron range
- Inline solution – no compromise in cycle time
- Measurement based on a 3D point cloud
- Foreign object and contamination detection



FLEXS.BOND

- Pressure-optimized injection for precise mixing of 2C materials
- Easy adaptation of mixing ratios
- Y- and Z-design available



PLUS.SUPPLY

- Vacuum technology cuts manual ventilation and material discard
- Improved process quality and bubble-free material supply
- Half-automated and sensor-controlled barrel change process

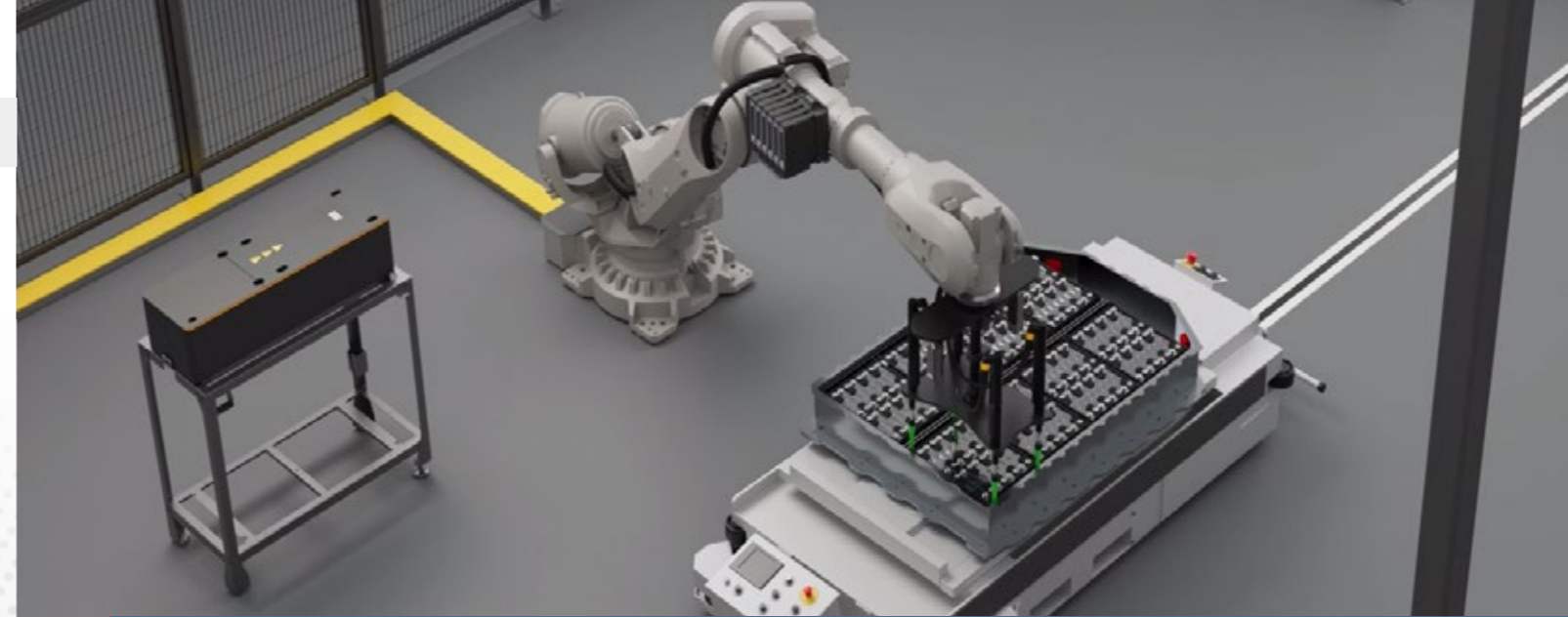

Automated, robot-assisted assembly for maximum precision in module assembly



- ⚠ Close contact between battery module and gap filler material
- ⚠ Soft and non-homogeneous gap filler material
- ⚠ Multiple utilization of one robot

After the process of dispensing the thermal compound, the module needs to be mounted and tightened on the battery tray.

CHALLENGES

The close contact between the battery module and the gap filler material is crucial to ensure thermal dissipation. The tightening process of a module to a battery tray is quite challenging because of the soft joint behaviour of the gap filler material. Furthermore, and depending on the available floor space inside the automated tightening cell, overall space for additional tightening controllers is very limited.

OUR SOLUTION

With the combination of our Multi Spindle and the PF6 FlexSystem with its synchronized spindle programmes, you are ideally prepared for complicated conditions such as the joining of battery modules and gap filler material. With the right tightening strategy and tightening sequence, we ensure the proper assembly process and efficient thermal transfer. Thanks to the flexible and compact carrier system, all needed components are directly available on the robot. That saves space for additional controllers and can reduce cable lengths by up to 90 %.



- ✓ System is directly mounted on the robot, saving space and cable length
- ✓ Common user interface from the Atlas Copco ecosystem. Saving extra trainings
- ✓ System can be used with already existing spindle technologies. High commonality
- ✓ Utilizing a single robot for multiple applications thanks to hot-swap and powerheads

Less consumption of resources thanks to reduced need for robots, cable length and controller rigs



MULTI SPINDLE

- Smallest dimensions for best accessibility
- Re-use of existing spindles
- Pitch adjustment



PF6 FLEX SYSTEM

- Compact, lightweight and modular
- Mounting direct on the robot
- Scalable solution thanks to carrier system

Watch Micro-Webinar



Error-free handheld tightening with maximum flexibility and safety

- ! Multiple product variants can increase errors and mistakes
- ! Perform structured quality assurance schedule
- ! Electric shocks due to short circuit

After adapting and connecting battery modules to the battery tray, the modules need to be connected and other electric components assembled. Several tasks increase the complexity of the assembly process and live battery components.

CHALLENGES

Increased assembly complexity with live battery components and multiple operations requires special procedures, equipment and tools. Different product variants in the assembly line and increased number of duties that the operators need to carry out bear error risks and can result in high rework costs. In addition, nearly every tightening in the battery pack is safety critical and documentation is mandatory. Another key factor in reducing costly rejects and rework in assembly lines is to plan and perform a structured quality assurance scheduling and to analyse the data promptly, deeply and efficiently. Should a handheld battery tool fall into the battery tray and on live components, any risk of electrical shocks to the operator must be eliminated.

OUR SOLUTION

Battery tools with an integrated controller, like the Tensor IxB models, allow maximum flexibility when it comes to line/workstation adjustments and different variants of battery trays. Tools with on-board controller save space and make rebalancing faster and more cost efficient.



Visualized operator guidance leads the operator through the assembly process step by step

In combination with precise bolt level positioning and localization solutions, you can guide your operators through the assembly process and ensure the first time right principle. This combination secures, that flexible battery tools are only active on a certain bolt and in a certain direction. To protect the operator against electrical shocks, battery tools can be equipped with isolated sockets and insulating tool covers. These accessories improve the operator safety while working on electrical batteries up to 1000V according to IEC 60900.

Quality Assurance is another key factor within assembly. With our comprehensive Quality Assurance accessories portfolio (QA Platform 4.0) you can perform quality checks in the line – e.g. like tool checks, joint checks, visual and dimensional inspections. All provided in a fully digitalized process and eliminating paper documentation as well as potential operator errors.



- ✓ Easy and fast rebalancing thanks to controller-on-board technology
- ✓ First time right principle thanks to bolt level localization
- ✓ Improved operator safety thanks to insulated accessories
- ✓ High process reliability and improved quality

✓ No more physical controllers needed = savings on resources and CO₂ footprint
 Lower energy consumption of an integrated controller compared to a physical one



SMART ASSEMBLY ECO SYSTEM

- Battery tools with cable tool performance
- Controller-on-board technology including Wifi diagnostics
- Operator guidance
- Industrial location



QA PLATFORM 4.0

- Tool, joint, visual and dimensional quality check by a single platform



HANDHELD ASSEMBLY SOLUTIONS

- Isolated sockets and quick change adapters
- Insulating tool covers



Unrivalled sealing quality with integrated vision solutions



- ⚠ Prevent gas evaporation and humidity ingress
- ⚠ Complex designs and part geometries inside the battery tray
- ⚠ Quality assurance even with deviations and difficult contrast conditions

To prevent harmful gas evaporation and humidity ingress that could impact safety and performance of the battery, there are several sealing steps required in the joining process.

CHALLENGES

The inner contours of the battery tray need to be sealed. Complex part geometries and position deviations during production can make accessibility and precision difficult and involve high programming effort. Depending on the part contours, different seam geometries may be required to achieve 100% tightness.

When it comes to cover sealing, an uninterrupted bead, precise bead beginnings and ends, and an even bead height are mandatory. At the same time, the seam must be reversible to enable repairs. Due to its permanently elastic properties, hot butyl is well suited for this, but the material needs to be heated up to 160 °C for optimal processing. With black material seals on black coated surfaces, visual quality inspection is challenging.

OUR SOLUTION

The unique combination and integration of vision solutions with our high-precision SCA dispensing technology increases the efficiency of the sealing processes and achieves an unrivalled quality right from the start.

Tray sealing: According to the geometry in the battery tray, our E-Swirl 2AdX applicator can seamlessly switch between bead and swirl application. With a flexible application distance, E-Swirl enables a stable process window and quality even with difficult accessibility. Combined with our ISRA VISION robot guidance solution SHAPEMATCH3D, we ensure that position deviations of the battery tray are considered before starting the application. The application starts precisely at the correct position.

Cover sealing: Our hot meter optimally tempers hot materials for a perfect cover sealing result with clean bead beginnings and ends. The inline 3D vision inspection solution RTVision.3d inspects the width, height, and continuity of the bead during the application as well as the applied volume. It also monitors the distance from the center of the bead to the component edge to check accurate positioning. Any deviations are detected in real-time. Thanks to laser technology we can easily inspect the bead despite challenging color mixes (e.g. black on black).

TRAY SEALING

- ✓ One applicator for different bead patterns saves a robot
- ✓ Quality assurance due to precise application and robot guidance
- ✓ High flexibility and productivity, reduction of waste and rework

COVER SEALING

- ✓ Tight and reversible cover sealing application
- ✓ Increased productivity and reliability: Fully heated system from barrel to nozzle
- ✓ 360° application coverage ensures 100% bead inspection

Significant material savings and scrap reduction due to greatly improved sealing quality



E-SWIRL 2ADX

- One applicator for bead and swirl pattern
- Flexible application width: 10–50 mm (depending on material)
- Flexible application distance up to 80 mm (depending on material)

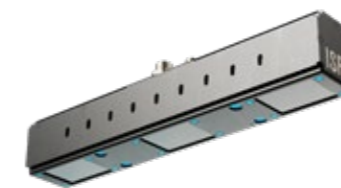

SHAPEMATCH3D

- Determination of position deviations for robot and dispense guidance
- Multi-line triangulation combined with integrated LED surface illumination
- Suitable for challenging geometries

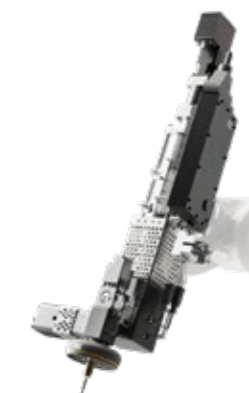

HOT METER

- Optimal material tempering up to 180 °C
- Heated and insulated material chamber, application housing
- Thermal decoupling



RTVISION.3D

- Six cameras and lasers for maximum curve coverage
- Laser class 2: only basic security level required
- No re-teaching of inspection system needed due to robot speed change



Innovation to cover safety-critical issues



- ⚠ Meeting safety-critical requirements
- ⚠ Precise application of 2C materials on wide areas
- ⚠ Potential health risk from material particles

In the unlikely event of EV battery cells igniting, there is a risk that they will burn through the battery cover. For example, the latest safety regulations in China specify that a passenger must have at least five minutes to leave the vehicle in case of a fire emergency. One approach is to cover the battery lid with a layer of a liquid applied fire-resistant material. These are often two-component (2C) materials.

CHALLENGES

The material layer must have a defined thickness on the entire surface of the cover. Gaps and overlaps must be within tight tolerance ranges to avoid issues in downstream production processes. Typical spray applications of materials like epoxy have many disadvantages. Material particles in the air are a health risk. Spray applications also require masking, resulting in waste and factory contamination. It needs high investments to protect workers and equipment. The alternative is a flat stream application. But applying 2C materials with flat stream has been difficult up to now.

OUR SOLUTION

For this emerging safety requirement, we have developed a solution to apply 2C materials in a sharp-edged flat stream. Our special SCA FlexS.Seal applicator mixes two components with high precision. An additional needle valve at the nozzle ensures that the mixed material is dispensed with the right pressure. The valve is optimized to avoid material residues that could affect quality. With this, we achieve a fast, accurate, and uniform application on large surfaces with clean beginnings and ends. You reduce health risks, material waste, and masking with no overspray issues.

For quality assurance, you can add a vision solution to your application system. RTVision.s inspects the surface after the application and provides reliable feedback on the application quality. It recognizes gaps or edge blur.

- ✓ Sharp-edged application with no overspray
- ✓ Reduced factory contamination and health risk
- ✓ Less material demand through precise application
- ✓ Cost savings and less waste due to reduction of masking efforts
- ✓ Effective quality assurance thanks to 2D post-process inspection

Reduced CO₂ emissions due to less material demand, waste and rework, reduced masking



FLEXS.SEAL

- Flat stream application of 2C materials
- Pressure optimization through additional needle valve ensures sharp edges
- Dead space optimized to avoid material residues

RTVISION.S

- Camera and light panels can be cascaded and extended as needed
- Powerful flashes that fire in sync with the camera's image capture eliminating ambient light effects
- Working distance from 400 mm to 1.200 mm



Fast and accurate cover joining



- ⓘ *Powerful joining in a sensitive environment*
- ⓘ *High number of multi-material joints at short cycle times*
- ⓘ *Precision despite part tolerances*

One of the last steps in battery manufacturing is joining the battery cover to the battery tray. For this step, multiple fasteners are required. An essential constraint at this point is that the cover is only accessible from the outside. The cover must be safely joined while remaining detachable to facilitate maintenance and dismantling.

CHALLENGES

The major challenge is to produce a large number of joints in a short cycle time and with consistent quality. Irregularities such as part tolerances, position deviations, or contaminations tend to complicate the process. Any error in this process step can damage the battery's exterior, lead to weak joints, harm the sensitive cells, and lead to dangerous short circuits affecting the performance and the overall safety of the battery. Due to its mixed material composition, the tray needs solid joints. Pre-treatment inconsistencies, such as pre-holes and part deviations, must be considered. Therefore, a flexible and reliable production system is needed.

OUR SOLUTION

Our K-Flow flow drill fastening technology combined with the ISRA VISION sensor SHAPEMATCH3D and the exclusive function "Pre-hole.Centering", offers fast and accurate joining – in a compact solution bundle.

The new K-Flow magazine technology HLX-70S is directly mounted to the K-Flow joining tool and can hold up to 70 fasteners. The new servo-driven magazine technology doesn't need feeding hoses resulting in reduced air and energy consumption while increasing the assembly productivity and flexibility. This new solution reduces cycle times as well as contamination at the joint. Another benefit of the HLX-70S is the fast loading time. The magazine can be reloaded in under ten seconds, decreasing cycle times by up to a third.

In conjunction with SHAPEMATCH3D, the joint and production quality can be increased even further. The "Pre-hole.Centering" functionality finds the battery cover pre-hole centerpoints and the robot guidance system sends an offset to re-center the tool head according to the distribution of holes on the part. This increases production quality and reduces the risk that the battery cover will be damaged when removed from the tray.

This compact solution offers powerful, high-quality joints even when part tolerances interfere, increasing the productivity and sustainability of the process due to significant savings in compressed air, floor space, and reduced scrap and rework.

HLX-70S

- ✓ 64 % less compressed air needed compared to a standard blow feed system
- ✓ Reduction of cycle times by up to a third
- ✓ Hoseless design for a more flexible production

PRE-HOLE.CENTERING

- ✓ Quality controlled applications
- ✓ Reduced rework and rejects from weak joints
- ✓ Increased machine uptime due to less joining errors

Magazine technology reduces CO₂ emissions as it saves more than 64 % compressed air compared to a blow feed system

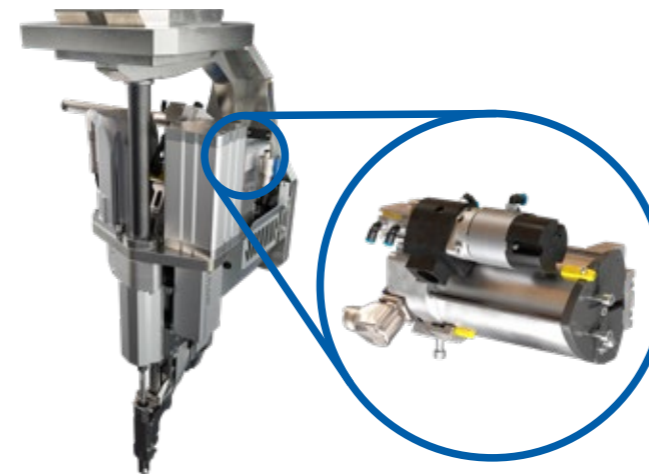

K-FLOW TOOL WITH HLX-70S

- Can hold up to 70 fasteners
- Refilling time less than 10 seconds
- New servo driven helix and EtherCAT communication

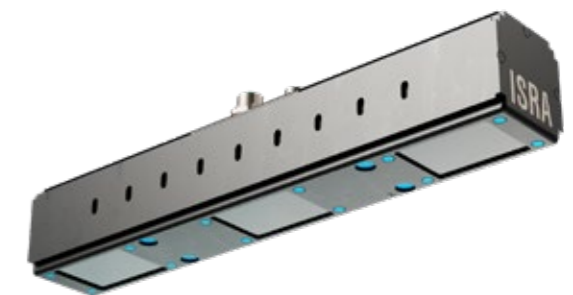

SHAPEMATCH3D WITH "PRE-HOLE.CENTERING"

- Determination of position deviations for robot guidance
- Multi-line triangulation combined with integrated LED surface illumination
- Suitable for challenging geometries

[Watch Live Demo](#)



Pinpoint protection of battery cover joints and edges



- ⓘ Long-term corrosion protection at critical spots
- ⓘ Handling demanding geometries at joints and trim edges
- ⓘ Avoiding manual rework, masking, and material waste

At the end of the battery manufacturing process, the critical areas of the battery need to be sealed to avoid corrosion. State-of-the-art battery designs have many surface breaks, trim edges and joints. For example, mechanical cover-to-tray joining can cause slight damage to the lid's coating. At these spots, moisture can enter, and there is a high risk for corrosion. Anti-corrosion materials such as special waxes can be applied to protect these areas.

CHALLENGES

The application process at the surface of the battery with its many contours, edges, and joints is challenging. Common manual or automated spray applications lead to manual rework, masking effort and material waste. This affects the productivity and the quality of the corrosion protection process. On top of that, serviceability aspects may need to be considered. If the joining elements are covered with material, loosening the screws for repairs is difficult.



OUR SOLUTION

IDDA.Seal is an intelligent and dynamic drop application that can also process waxes. Every single droplet can be controlled individually. This allows for the highest precision and a fully flexible bead geometry. The bead width and thickness can be perfectly adjusted to your requirements. You can apply the material as thinly and precisely as possible and use only as much material as necessary. Manual rework and material usage are cut to a minimum. For example, the head of the joining element can be omitted, which allows clean loosening of the screw for repairs.

Compared to conventional sealing technologies, IDDA is much more flexible in terms of application speed, distance, and angle. This improves accessibility, enables shorter application times, and increases your productivity. The application system can be combined with an ISRA VISION robot guidance solution. The MONO2.5D sensor measures customer-specific features such as holes, edges, corners or surfaces. We ensure that position deviations of the battery tray are considered before starting the application. The application starts precisely at the right position to achieve maximum process accuracy.

For large battery covers, two IDDA application systems working simultaneously can significantly reduce cycle time

- ✓ Fast and efficient application of corrosion material exactly where you need it
- ✓ Minimizing manual rework and material use
- ✓ Individual bead designs for highly complex part geometries
- ✓ Enabling serviceability for repairs
- ✓ Edge sharp application, no overspray, no masking
- ✓ Avoiding long-term warranty cost due to corrosion problems

Up to 40% less material demand due to pinpoint application precision, and increased battery lifetime



IDDA.SEAL

- Five valves that can be configured and controlled individually
- Application distance up to 80 mm
- Application speed up to 600 mm/s
- Application angle +/- 30°
- Push/Pull position up to 30°



MONO2.5D

- Precise detection of position and orientation
- Efficient object position determination in 4 degrees: x, y, z and Rz
- Low space requirements and ease of integration
- Process time below 500 ms



Economical assembly of cylindrical cells

Thousands of cylindrical cells are installed in a modern EV battery. Dispensing solutions need to be scalable to meet short cycle times. At the same time, complex structures and small-scale dispensing tasks require highly precise applications.

Due to their high energy density and cell manufacturers already having a lot of experience in design and production, cylindrical cells are popular. As with prismatic cells, the assembly process can vary greatly depending on the battery concept.

Honeycomb structures for example have proven effective in many concepts in fixing the cells securely. Into each honeycomb, a cylindrical cell is inserted, which must be bonded with a thermally conductive adhesive to create a strong mechanical and thermal connection. However, further downstream production steps, such as bonding of cooling ribbons, sidewall or clamshell bonding require complex dispensing tasks. Numerous dots and lines of mostly a two-component material must be applied at short cycle times. Common

single-nozzle solutions come with high investment costs and cannot achieve the required cycle times.

MULTI-NOZZLE DISPENSING

With the Scheugenpflug Multi-Nozzle Dispenser, we have a customized and economical solution for highly precise dispensing of small volumes. Depending on the production requirements and battery design, multiple individual metering units can be integrated into one system. It allows not only 1C and 2C materials but also liquid and paste-like materials to be applied in a very short time. Customers benefit from a scalable solution that comes with lower investment in plant and machinery, a smaller footprint, and a high degree of flexibility.

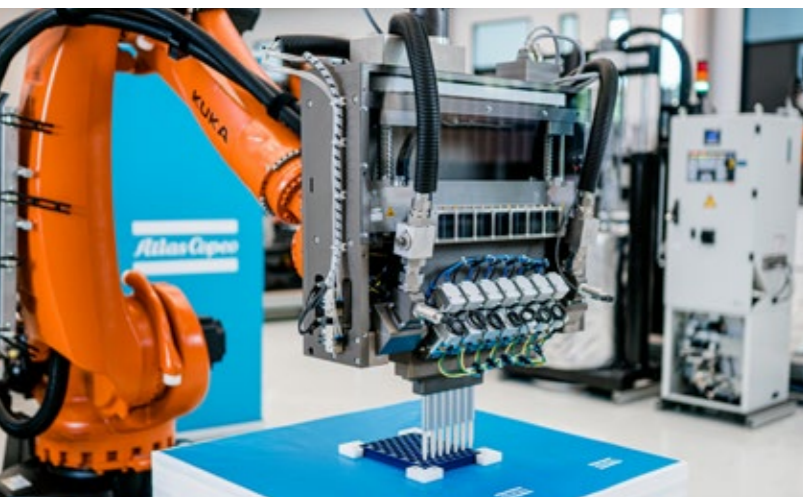
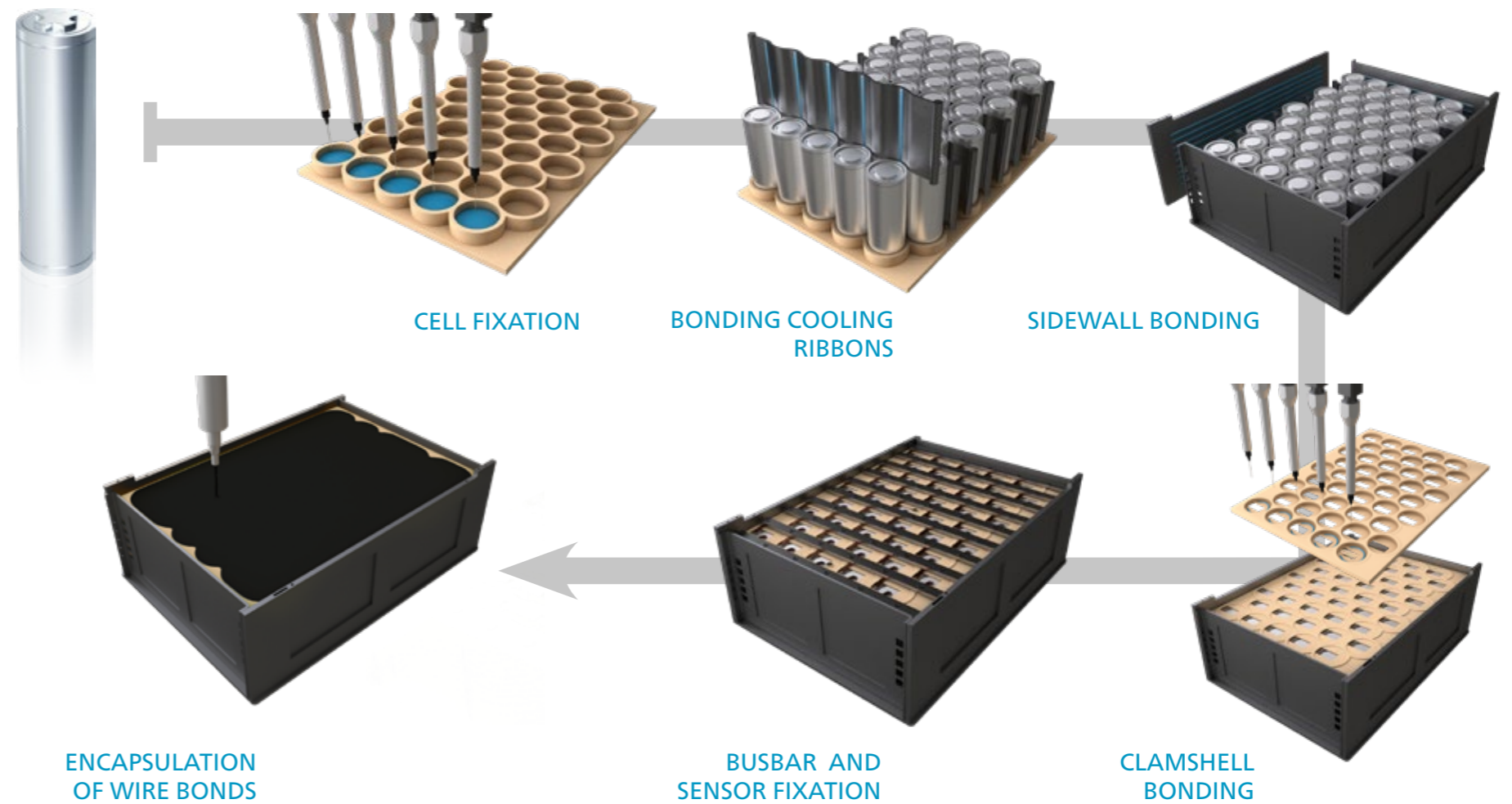

MULTI-NOZZLE DISPENSER

- Scalable solution with small footprint
- Mixing ratio and mixing quantity precisely defined for each mixing tube
- High flexibility due to individual nozzle control
- Can be integrated into robotics application

SCA

SCHEUGENPFLUG

A PERFECT COMPLEMENT

The materials used in these steps have very different compositions and flow properties. When it comes to preparing and processing materials, Atlas Copco connects both worlds: SCA with outstanding expertise in automotive bonding and sealing processes and Scheugenpflug with a strong know-how in electronics potting and material preparation. The smart combination of technologies allows us to cover the full range of viscosities and application processes. This is how we achieve the best application result for our customers – no matter how demanding the material or process.

Meeting electromobility and body shop trends with self-pierce riveting

In recent years, vehicle manufacturers have taken progressive new approaches to vehicle design and engineering. Automotive manufacturers are looking at advanced new materials as well as new structural strategies such as megacastings to reduce manufacturing costs and improve body strength. However, these trends bring new joining challenges that can be met with the Henrob self-pierce riveting (SPR) product line from Atlas Copco. The extensive Henrob rivet line is the only SPR on the market covering the wide range of newly introduced EV body materials.



SPR as the preferred joining process for EV manufacturing

The cleaner and safer environment provided by cold, fume-free SPR is preferred by body shop personnel. The dust, heat, and welding spatter generated from welding can pollute the body shop as well as the battery boxes during assembly.

GLOBAL AND LOCAL SPR SUPPORT FOR EV OEMS AND INTEGRATORS

The radical difference in speed and processes for how EV companies bring a product to market has changed the nature of the entire automotive industry. We have decades of experience in providing quick and dependable solutions with a secure global rivet supply chain and local responsiveness.

Atlas Copco experts partner with EVs and integrators across the vehicle manufacturing timeline to support:

- Material selection R&D
- Vehicle design for manufacture
- Joint development
- Body shop engineering
- Production line efficiency
- Plant issues



CUSTOMER CHALLENGES

€ Reduce manufacturing costs

- ! High part counts = high assembly costs
- ! Robot sizes & counts
- ! Cost of structural material
- ! Thermal joining infrastructure costs and other challenges

kg Reduce bodyweight

- ! Increase fuel efficiency for internal combustion engine vehicles
- ! Increase battery range for EVs

⚠ Increase safety

- ! Stronger materials
- ! More rigorous A- and B-pillar demands
- ! Better driver visibility

LARGE SCALE & LOW DUCTILITY NON-HEAT-TREATED CASTINGS

- Drastically reduces part counts and associated assembly process investment
- Avoiding heat-treatment saves time and money but reduces the formability required for mechanical joining

JOINING CHALLENGE

Castings that have not been heat treated are less ductile, and can incur edge splitting as the material is pushed into the die by the rivet. The increased property variation can make it difficult to consistently join to a wider range of materials.

OUR SOLUTIONS

D-rivets
Designed for piercing & joining high-strength steels & aluminum castings with good interlock

Ø 4 mm rivets
The lower rivet volume reduces the required material flow into the die and lessens the stress on the low-ductility material

DL die
A profile designed specifically for castings with low formability to improve corrosion resistance

HIGH-STRENGTH ALUMINUM FOR STRUCTURAL COMPONENTS

- HSAI use in pillars improves stiffness, safety and meets crash test demands
- The lighter weight avoids the penalties to fuel and battery efficiency from using steel

JOINING CHALLENGE

HSAI has lower formability and is often thicker gauges on narrower flanges, requiring fitting a structurally strong enough fastener range with the necessary lengths for the thicker joints.

OUR SOLUTIONS

BG-, NG, & YG-rivets
Designed for piercing high-strength materials with consistent joint strength

Ø 4 mm rivets
The smaller head can fit on a narrower flange, while the wider shank allows for structural joining

NARROW FLANGE SPECIFICATION

- Less structural material
- Reduced body weight
- Improved driver visibility

JOINING CHALLENGE

The reduced surface area leaves less room for tooling and fasteners. Manufacturing tolerance build up can risk bad joints. If the rivets get too close to the edge, there can be reduced strength or impaired corrosion-resistance.

OUR SOLUTIONS

Narrow flange nose systems
Reduces the interface diameter between the nose and the material, while maintaining support of the rivet

Ø 4 mm rivets
The smaller head can fit on a narrower flange, while the wider shank allows for structural joining. Moving the rivet farther from the edge reduces the risk of edge effects



The aim of quality control is to reduce waste, eliminate defects, and continuously enhance the level of quality during the manufacturing process

Manufacturing success depends on quality

Combining machine vision solutions with our broad joining and dispensing technologies we at Atlas Copco optimize your production processes, also increasing productivity, product quality and data processing.

Precisely defined quality standards must be met at every stage of the manufacturing process. The role of quality control is to ensure that all products are defect-free, that the manufacturing process minimizes waste, and that the final product meets the customer's expectations before it leaves the plant.

When it comes to digitalization, machine vision is recognized as one of the leading technologies. Machine vision adds value to quality control processes by fully automating them, making them more productive and cost-effective. In many companies, quality control is still a manual operation. Although the ability of humans to visually inspect different objects is very high, subjectivity and fatigue resulting from performing repetitive tasks can lead to human error.

With the acquisition of the companies ISRA Vision, Perceptron and QUISS, we at Atlas Copco are focusing on compounding our joining and dispensing technologies with machine vision systems for industrial quality control inspections. Our customers benefit from a complete, holistic solution for automation, robot guidance and visual quality inspection from a single source.

With 2D and 3D quality inspection systems, we offer a wide range of applications:

- Bead inspection
- Surface and depth inspection
- Robot vision

INSPECT



Bead inspection

2D post-process 2D in-process 3D in-process



RTVision.s RTVision.t RTVision.3d

MEASURE



Surface inspection

3D in-process



Smart.Adjust

CONTROL



Robot vision

3D in-process



SHAPEMATCH3D MONO 2D/2.5D/3D

2D AND 3D IN-PROCESS: (RTVision.t and RTVision.3d)

The inspection takes place directly in process, which means:

- No additional cycle time is required for the qualitative assessment
- Full quality control of all produced parts
- Thanks to 3D laser technology, inspection is feasible even with difficult contrast ratios (e. g. black bead on black surface)

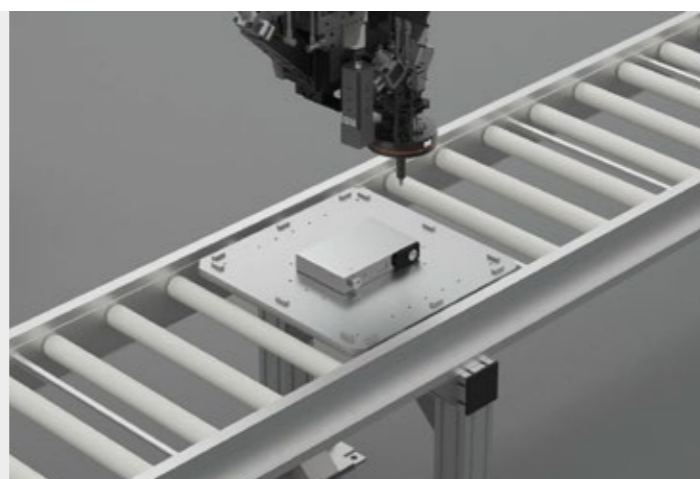

2D POST-PROCESS: (RTVision.s)

The inspection takes place after the actual application process:

- Inspection of different adhesive dispensing materials and applications in one step (e. g. round bead, stitch bead, swirl, flat stream)
- Flexibility tailored to the manufacturing process (vision system is very adaptable in configuration)

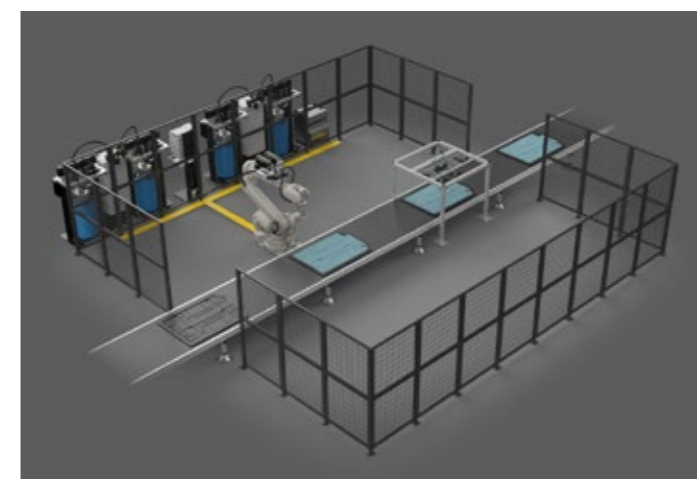



Innovating together for a better tomorrow

Industrial revolutions like electromobility don't happen overnight. They are the result of years of research, innovation and testing – in a global network of manufacturers, institutes, economical requirements and many more. Simple things need to be reworked, redesigned and rethought. Such changes need a space where ideas and innovations can grow – and our global Innovation Centers are one of those places where revolutions can begin.

WE TRANSFORM INDUSTRIAL CHALLENGES INTO INDUSTRIAL INNOVATIONS

Our global network of 13 Innovation Centers combines joining expertise, assembly technologies and manufacturing competences under one roof, to provide the best possible manufacturing solutions for our customers.

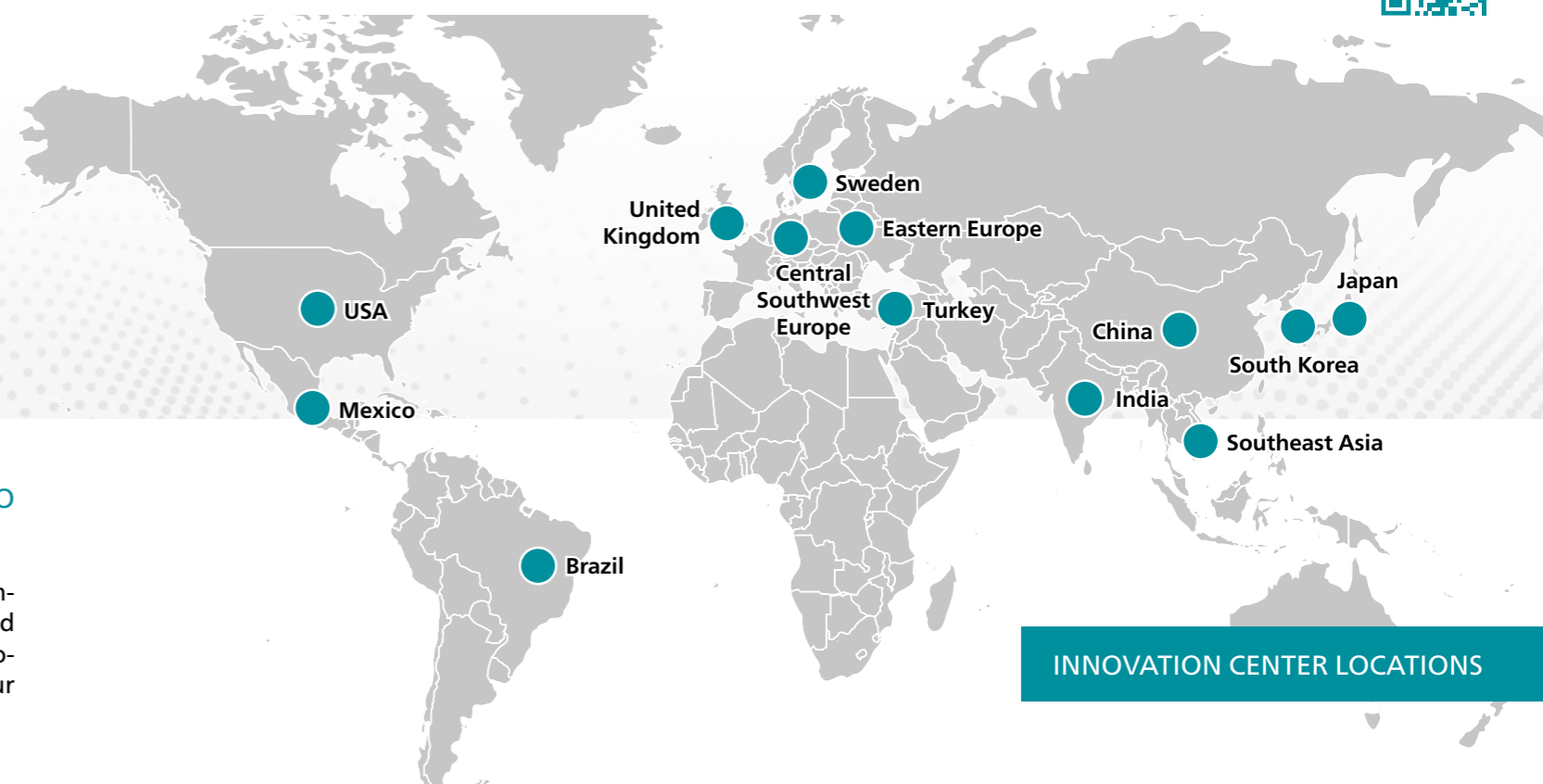

INNOVATION CENTER LOCATIONS

MAIN BENEFITS OF OUR INNOVATION CENTERS :

- ✓ Access to a global network of 13 Innovation Centers
- ✓ Experienced team of joining, assembly and vision experts
- ✓ Holistic approach to the development process, from part measurement to quality assurance
- ✓ Real-life testing and evaluation of applications
- ✓ Dedicated robot cells and various robots from common manufacturers for development and testing
- ✓ Comprehensive analysis labs for joint analysis and tensile testing

We offer a comprehensive innovation partnership that accompanies our customers every step of the way. From the initial idea to a highly automated production process ready to run. We engineer and develop a holistic joining and assembly process tailored to their needs. Our extensive competence and experience help solve challenges in the EV battery assembly process and any automotive joining process.

We can also offer the unique opportunity to install and program an entire system and run the newly developed

application in reasonable quantities before start of production. This minimizes start-up efforts and reduces risk right from the beginning of production.

At Atlas Copco, we understand that the perfect joint is a complex interaction between multiple players. In our Innovation Centers, we work with our customers to ensure they have the perfect fit between technologies, materials and processes – right down to hybrid joints, such as combining adhesive bonding and mechanical joining. Let's get started!

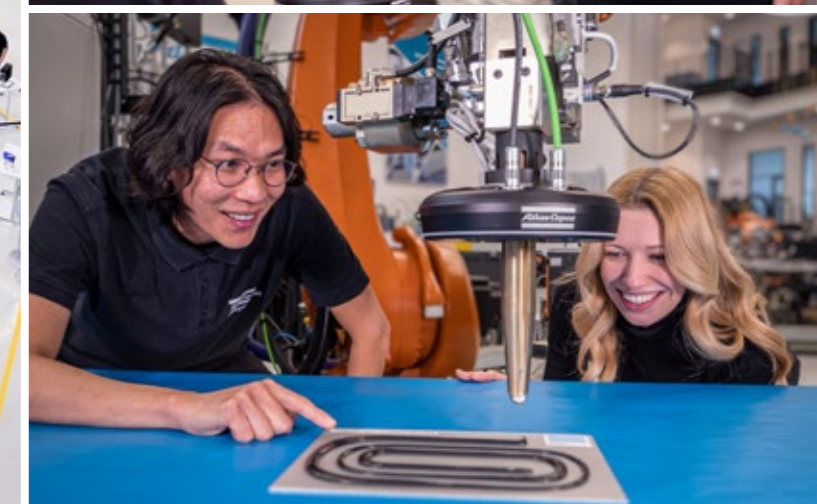



We are committed to the Science Based Targets initiative
Learn more on: sciencebasedtargets.org



INNOVATION SPOTLIGHT

Plus.Supply

CHALLENGE

Costly materials (e. g. for gap filler applications), frequent and complicated barrel changes and a lot of material loss in the process

OUR SOLUTION

Combination of flat follower plate and vacuum technology in material supply

SUSTAINABILITY IMPACT

- 🌱 Nearly zero waste material supply
- 🌱 Increased material efficiency by 10%
- 🌱 Saves 30 barrels with an annual consumption of 1000 barrels
- 🌱 Up to 65 tons of CO₂ savings per system and year

Creating impact from design to second life

How can we make e-mobility a real game changer in the fight against climate change and truly save resources and emissions? At Atlas Copco, we do not have THE one answer to this. But we have a holistic, science-based approach to sustainability – and innovations that impact the total value chain.

We start right at the design stage. At our Innovation Centers, we help our customers lay the foundations for consuming fewer resources over the entire life cycle of the electric vehicle – which also means enabling circularity by design. During car body and battery production, our technologies and applications contribute to the durability of the end product, reduce material usage and waste, and decrease cycle time and

energy consumption. Our strong aim is to support our customers in reaching their environmental targets and KPIs in the manufacturing process. With dedicated services, we prolong the lifetime of products and parts through preventive maintenance, repair, and refurbishment. When the second life of the battery has begun, it pays off that our customers have chosen Atlas Copco because our technologies enhance reparability and recycling.

We believe partnering up with our customers and joining innovation forces is vital. This is the only way we will have the chance to sustainably overcome key challenges such as weight and cost reduction, lowering complexity, as well as increasing material efficiency.

Innovations that contribute to a more sustainable production

<p>Energy-optimized technologies</p>	<p>Precise applications</p>	<p>Measure, calculate, adjust</p>	<p>Material supply and preparation</p>	<p>Quality assurance</p>
<p>Joining technologies that run on low power levels, require less compressed air and floor space</p>	<p>Less material demand, less rework and less scrap due to right first time applications</p>	<p>Material and weight savings through smart integrated vision and software solutions</p>	<p>Solutions that reduce purging waste, leftover in the barrel and disposal efforts</p>	<p>Bead inspection solutions reduce scrap, rework and material waste</p>



The game-changing role of data-driven services in EV battery production

The production of electric vehicles and EV batteries is accelerating globally and becoming increasingly competitive. The main challenges for manufacturers are time-to-market, high throughput targets, and reduced production costs while ensuring quality and optimal performance. What can help manufacturers overcome these challenges? Data is the answer! But HOW?

START IT RIGHT

At the first step of the process, a fast and efficient installation of new equipment is essential to provide purposeful data collection. With our Atlas Copco installation service we ensure that the hardware and analysis software share data correctly to monitor the entire process.

UNLOCK THE POWER OF DATA

Once data is collected and shared, the next challenge arises. Data is powerful but requires insights to become more than just numbers and generate value. Developing more complex products can cause a higher recall rate or release of defective products. For this reason, advanced analytics and machine learning are essential to ensure operational efficiency and high-quality performance. Moreover, innovative production processes can reduce costs from 15% to 30%¹. Employing data-driven solutions and next-generation digital technologies is critical to minimizing production downtime and improving accuracy by identifying issues.

To help customers collect and manage data properly, Atlas Copco introduces **ToolsNet 8**, a real-time process monitoring and traceability software for tightening, self-pierce riveting, adhesive dispensing, and flow-drill fastening. ToolsNet 8 documents applications from each system and station, providing you with complete knowledge of every single joining process. ToolsNet 8 allows you to backtrack the issues, understand the root causes and collect the right insights to improve the process. In addition, ToolsNet 8 monitors your process in real time and notifies you when your machines or processes show deviations. This allows you to shorten response times and save time when production problems occur.

To further support EV battery manufacturers with data analysis and reduce unnecessary costs, we offer **ALTURE® Data-Driven Service Solutions**. This easy-to-use app proactively analyzes production data and identifies issues and quality concerns in real-time. Tightening failures are instantly notified through mobile push notifications, allowing immediate action and avoiding costly consequences. Moreover, the reports include relevant information about the issue and even provide recommendations for solving it, regardless of the expertise level.

¹ Campagnol, N., Pfeiffer, A. & Tryggstad, C. (2022, January 7). Capturing the battery value-chain opportunity. McKinsey & Company. <https://www.mckinsey.com/industries/electric-power-and-natural-gas/our-insights/capturing-the-battery-value-chain-opportunity>

*currently only available for tightening tools
**currently available for self-pierce riveting, dispensing, and flow-drill fastening equipment



ToolsNet 8

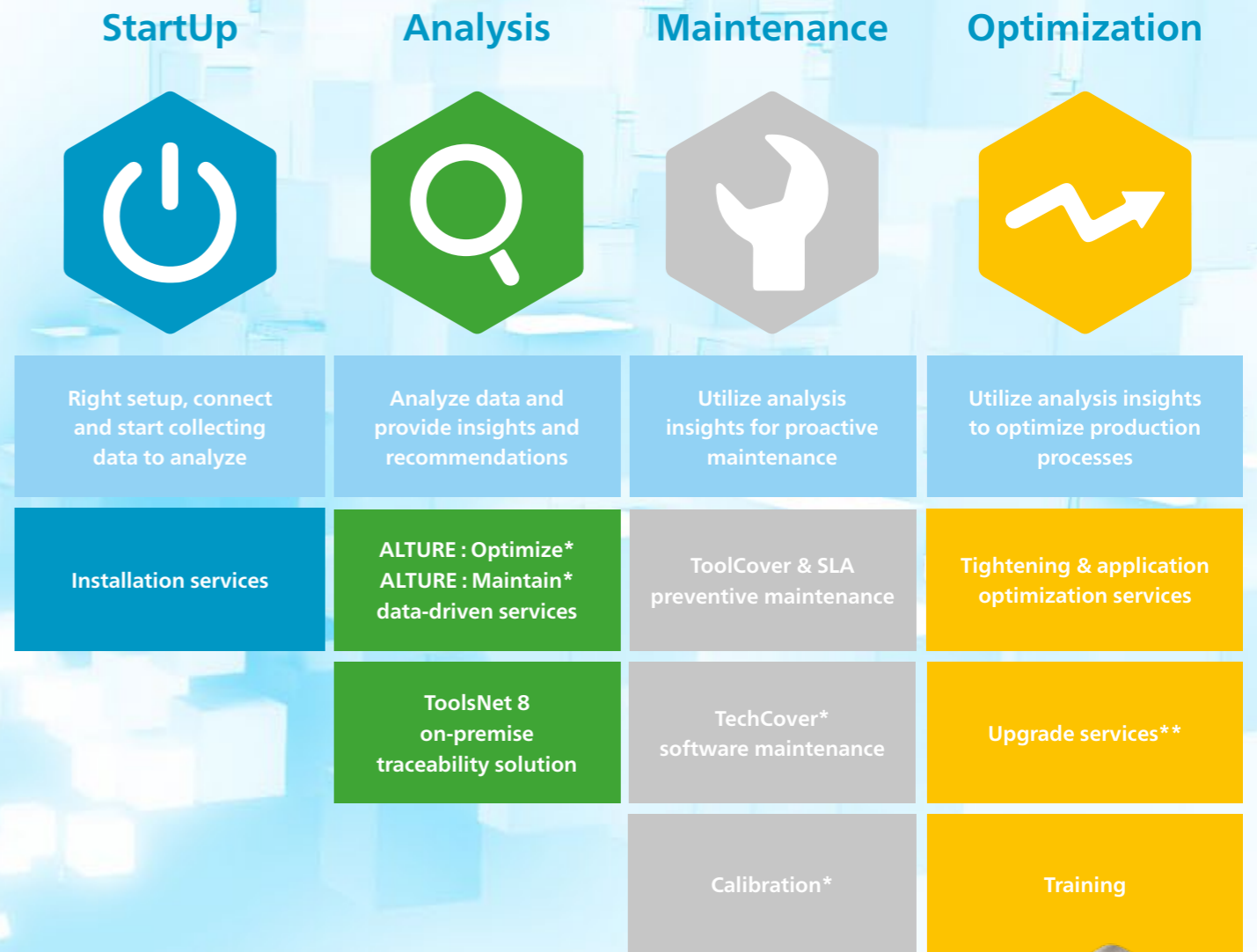

SIMPLIFIED AND SOLUTION-ORIENTED



ALTURE : Maintain as well as **ToolsNet 8** provide recommendations and schedules for necessary maintenance for assembly tools and joining equipment, which is essential to reduce downtimes and costly consequences and improve overall quality.



On the other hand, **ALTURE : Optimize** identifies outstanding tightening trends that can lead to future problems, helping our customers to anticipate issues before they occur. Thanks to the insights provided by **ALTURE : Optimize**, we can suggest tightening optimization solutions targeted to the customer's specific needs. Our certified technicians can implement changes to optimize the process and improve productivity and first-time quality.

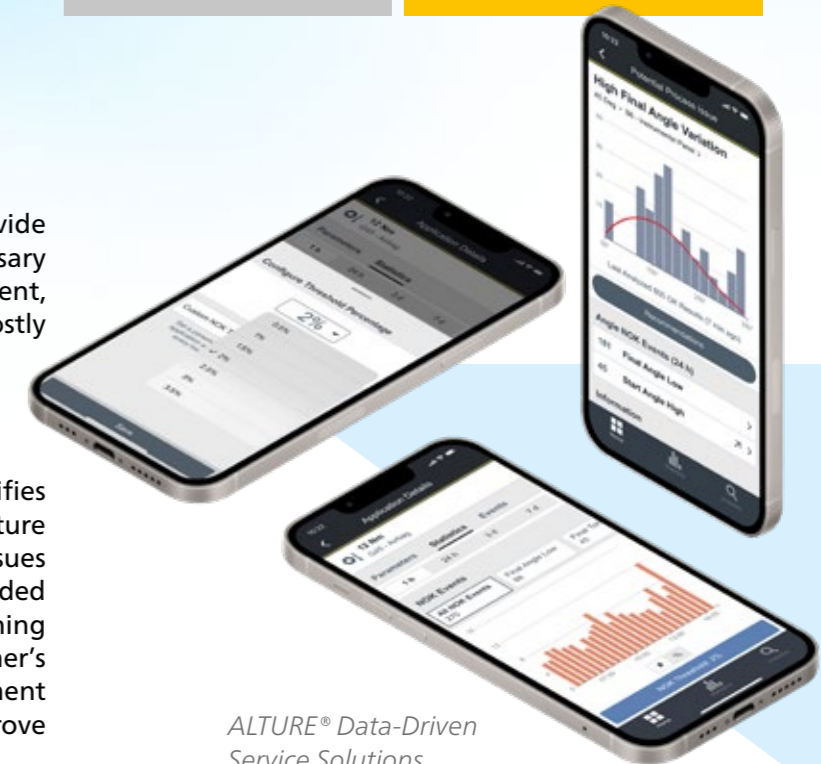

ALTURE® Data-Driven Service Solutions



Atlas Copco IAS GmbH
Industrial Assembly Solutions

Gewerbestr. 52 | 75015 Bretten – Germany
joining.atlascopco.com

